

Accessories

Model THP Tweezer Handpiece

- Includes 1 Pair
ET0402 Electrodes



Model PHP Probe Handpiece

- Includes 1 Pair
EP0402
Electrodes
for handpiece
and 1 pair
EP0802 for probe

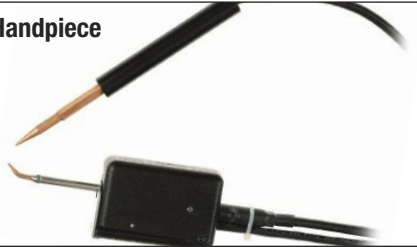

Model HFP High Force Probe

- Includes 1 Pair
EP0802 Electrodes



Model GHP Gun Handpiece

- Includes 1 Pair
EP0802 Electrodes,
straight extension
and 30° elbow
adapter



Model HDHP Heavy Duty Handpiece

- Includes 1 EP0902 Straight Electrode,
35 or 90 degree electrodes available
- 4-30149-02, 10 ft #2 gauge grounding
cable sold separately



Model VBTWK/115, Ball Tacking Kit

- Includes vacuum pump,
vacuum adapter, tubing
and 2 electrodes for
1 mm ball. Used with
GHP and HFP



10-400-01, VBTWK/115V
10-400-02, VBTWK/230V

A successful resistance spot welding process generally requires a welding power supply, a spot welding head, and a weld monitor or weld checker. Selecting the right accessories for these critical components can enhance and improve your results, and provide additional safety for your operators.

HANDPIECES

Generally speaking, welding handpieces should be used only when it is impractical to use a welding head. Their relative ease of use, combined with low maintenance and flexibility, make them well-suited for small batch production and R&D environments.

- Both the Model THP tweezer, and PHP probe handpiece are used to weld small parts which require less than 125 watt-seconds or 1/2 cycle AC, and welding forces less than 7 pounds. The Model HFP high force probe is used for applications which require higher energy and/or force than either THP or PHP. All three models are force fired to ensure repeatability.

- The Model GHP and HDHP are switch fired handpieces and can be used to weld or tack materials that don't require stringent force control.

Handpieces are available with either 4 ft or 10 ft long cables. As a general rule, the energy delivered to the workpiece with 10 ft #6 cables will be approximately 15% of that delivered with 4 ft #6 cables. Handpieces are furnished with cables, as indicated in the following table, and one pair of RWMA electrodes.

Rating	THP	PHP	HFP	GHP	HDHP
DC (watt seconds)	125	125	500	125	500
AC (KVA-1/2 cycle)	2	2	7.5	2	10
Force Range – Max (Min)	7 lbs (1.0 lbs)	7 lbs (1.0 lbs)	25 lbs (3 lbs)	N/A	N/A
Cable Size (AWG)	#2 or #6	#2 or #6	#2	#2 or #6	#2
Cable Length	4 ft or 10 ft	4 ft or 10 ft	5 ft or 10 ft	4 ft or 10 ft	7 ft
Electrode Series	ET0400	EP0400 or EP0400	EP0800 and EP0800	EP0800	EP0900

Accessories are an important part of any welding system. For your convenience AMADA MIYACHI AMERICA provides:

Index	Page
Welding Handpieces.....	1
Optics and Illumination Accessories	2
Chillers, Fume Extractors, Pull Tester	3
Footpedals and Footswitches	4
Electrode Force Gauges.....	5
Electrode Material and Electrodes.....	5-6
Unibond and Unitip Electrodes.....	7
Kovar Ribbon, Polishing Disks, Tab Material	7
Cables, Terminals, Connectors and Adapters.....	8
Electrode Holders and Adapters.....	9
Starter and Calibration Kits.....	9

For assistance in selecting accessories or for accessories not included in this data sheet, contact your local AMADA MIYACHI AMERICA sales representative or telephone our customer service department at (626) 303-5676.

OPTIC ACCESSORIES

The Model SMZ-660 Stereo Zoom Optic Pod (1) is supplied with 10X Eyepieces and a 0.5X Objective Lens. It provides magnification which is adjustable from 4.0-25X and a working distance of 211 mm. Its lightweight housing is airtight, anti-mold and anti-electrostatic. It includes the C-Bonder Arm and is compatible with any Model 50 or 80 Series welding head.

The Model OMA optic mounting assembly (2) provides the posts and hardware required to support the optic pod. The Model BPTL, Thin-Line base plate (3) is drilled to accept all 80 Series Thin-Line weld heads and the optic mounting assembly. The base plate is 6 inches wide x 14-7/8 in deep x 1/4 in (15.2 cm x 37.8 cm x 6.3 mm). The BLFOI fiber optic illuminator system (4) transmits light through bifurcated, fiber optic light guides to produce cool, flicker-free, high-intensity light at the worksite. The Model BLFOI operates at 115 volts, 50/60 Hz. Specify Model BLFOI/230 for operation at 230 volts, 50/60Hz.

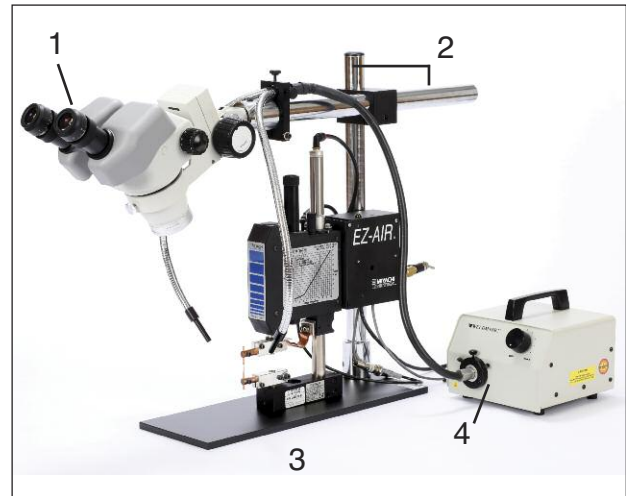

MODEL TMMWC



Boom Stand sold separately

The Model TMMWC (Trinocular Mounted Microscope with Camera) Stereo Zoom Microscope is supplied with 10X Eyepieces and a 0.5X Objective Lens. It provides magnification which is adjustable from 4.0-25X and a working distance of 211 mm. It is available with Mounting Kits for weld

heads shown in table below or sold as standalone system using part number 270-607 noted below. It is compatible with most 70 & 80 Series welding heads.

LOUPE

An eye loupe is an indispensable item for quick observation. This pocket sized tool will magnify the process 10x and allows for the first line of inspection.



MICROSCOPE KITS

Kit Number	Description	Applicable Weld Heads
10-430-01	SMZ-660 Stereo Microscope kit, Includes OMA, BPTL and BFLOI, 120 V	80F,80A/EZ,86,87A/EZ
10-430-02	SMZ-660 Stereo Microscope kit, Includes OMA, BPTL and BFLOI, 230 V	80F,80A/EZ,86,87A/EZ
10-431-01	SMZ-660 Stereo Microscope kit, Includes OMA, and BFLOI, 120 V	71 Weld head
10-431-02	SMZ-660 Stereo Microscope kit, Includes OMA, and BFLOI, 230 V	71 Weld head
10-432-01	SMZ-660 Stereo Microscope kit, Includes OMA2, and BFLOI, 120 V	72/180 Weld Heads
10-432-02	SMZ-660 Stereo Microscope kit, Includes OMA2, and BFLOI, 230 V	72/180 Weld Heads
10-440-01*	IVSC, Inspection Station, Includes Macro lens, Stand, Ring light, Smart Camera w/measurement tool, 23 in LCD monitor	N/A
10-450-01*	TMMWC-120, Trinocular Micro Scope Kit, Includes 1080P HD Camera, 23 in LCD Monitor, OMA, BPTL and BFLOI, 120 V	80F,80A/EZ,86,87A/EZ
10-450-02*	TMMWC-230, Trinocular Micro Scope Kit, Includes 1080P HD Camera, 23 in LCD Monitor, OMA, BPTL and BFLOI, 230 V	80F,80A/EZ,86,87A/EZ
10-451-01*	TMMWC-120, Trinocular Micro Scope Kit, Includes 1080P HD Camera, 23 in LCD Monitor, OMA2, BPTL and BFLOI, 120 V	72/180 Weld Heads
10-451-02*	TMMWC-120, Trinocular Micro Scope Kit, Includes 1080P HD Camera, 23 in LCD Monitor, OMA2, BPTL and BFLOI, 230 V	72/180 Weld Heads
270-607*	Trinocular Microscope System, Includes Trinocular Stereo Microscope, 0.4x video coupler, 10x eyepieces and 0.5x Objective lens, Focus Mount, 1080P HD camera, 23 in LCD monitor,	50 Series weld heads, and any weld head with existing Microscope mount. Requires BFLOI light source
475-549	Jeweler's Loupe	N/A
8-453-01	USB Microscope and Stand	N/A

*Includes image capture software

IVSC VISION SYSTEM



The Model IVSC (Inspection Vision System w/Camera) is a standalone system and contains a Macro video lens on extended post stand with HD Measurement camera and diffused LED ring light. Includes 23 in LCD monitor and Flash Card for saving images.

MAGNIFICATION

In many cases, the process is smaller than what the human eye can see, thus magnification is key to properly observing the process results. We offer a range of different magnification devices that can be used to look at the weld to detect small defects. An eye loupe is an indispensable item that can be used for quick observation. To take pictures of the process, portable, USB microscope, desktop stereoscopes, and Trinocular Microscopes are available.



USB Microscope and stand

FUME EXTRACTION

Spot welding, fusing and brazing are all processes that can eject material of various sizes from the part. Fume extractors are necessary to remove harmful airborne particles so that operators and engineers are not exposed. These sometimes toxic fumes need to be collected and properly filtered. Use the following table to identify the best fume extractor for a given process:



Part Name	Part Number	Process
Fume Extractor-Small	4-61359-01	Spot welding
Fume Extractor-Large	720-225	Fusing, Brazing

WATER CHILLERS

Water chillers are necessary for cooling higher powered welders. They control the temperature of the water to keep condensation from building when facility water cannot. The following chillers provide the necessary cooling capacity for the approximate kVA Rating running at full power and duty cycle. The table below is a general rule, always consider each circuit in the welding system for required GPM (Gallons Per Minute)



Model	Part Number	kVA	GPM (STD)
OTC-1.0A Chiller	4-66736-02	<100	4
OTC-2.0A Chiller	4-66736-05	<200	7
OTC-5.0A Chiller	4-66736-07	<500	12
OTC-7.5A Chiller	4-66736-09	<500	18
Water connector kit, small	4-69984-01		
Water connector kit, large	4-66985-01		



VORTEX COLD AIR GUN

Cold Air Guns use vortex tube technology and filtered compressed air to produce sub-freezing air as low as -30 deg F for numerous industrial spot cooling applications. With no moving parts to wear out, Cold Air Guns require no electricity, just a compressed air source. The Vortex Cold Air Gun System includes a magnetic base and a 5 micron auto-drain compressed air filter. Great for spot cooling when water cooling is not sufficient or available.

Compressed air pressure: (psig) 80 – 100

Inlet size: (NPT pipe thread, inches) ¼

Minimum outlet temperature, deg F: (at 70 deg F inlet air) -10

Air consumption @ 100 psig: (scfm) 15

Outlet air flow rate: (scfm) 2 to 15

Dimensions, inches – overall length: 19 5/8,

Diameter: 1 ¾, nozzle length: 9

PULL TESTER

One method to test the strength of a weld is to pull the two joined materials apart. The 200 lb pull tester can be configured for tension or compression testing applications up to 200 lbF (890 N) for laboratory and production needs. The 10-420-01, 200 lbs pull tester comes with motorized test stand, force gauge, and wedge grips. Platform is customizable for specific applications.



ADAF

Auto drain air filter, 5 micron element, metal bowl with sight glass, differential pressure indicator, for use with all air actuated weld heads.



Part Name	Part Number	Description
PT-200	10-420-01	Pull Tester, 200 lbs
VTAC	285-155	Vortex Air Gun
ADAF	10-373-01	Compress Air Filter

FOOTSWITCHES FOR AIR ACTUATED HEADS

The Model FS2L two-level footswitch is intended for use with all AMADA MIYACHI power supplies. The first level actuates the weld head via the air valve driver of the power supply; the second level, along with the force firing switch in the weld head, initiates the welding current.

The Model FS1L one-level footswitch also may be used with all AMADA MIYACHI power supplies. The single level switch actuates the weld head and initiates the welding current simultaneously (when the firing switch closes).

MODEL FS

Single level Firing Switch without safety guard. Used to fire power supplies immediately upon initiation.



FOOTPEDALS

The Model CP cable pedal pivots under the heel for optimum force control. It is equipped with an adjustable down-stop which prevents the application of excess force. It is rated at 25 pounds, and can be used with the 50F, 80F, 86F, or 87F Thin-Line™ weld heads.

The Model MSP medium force swing pedal is fully adjustable for length, stroke, angle and left or right-foot operation. It provides a 5-to-1 mechanical advantage and is rated at 100 pounds. It is used with 83F, 84F, 88F, 89F, and 180F Thin-Line weld heads.



DISPLACEMENT SENSORS

Displacement sensors can be used to measure initial part thickness, collapse during weld, and final part thickness. When used with the proper weld control or weld monitor, displacement sensors can also be used to stop the weld when the desired collapse has occurred.

Model	IPB-5000A	MM-370B	ADAM™	MG3
GS-1813 (13 mm)	X	X		
GS-1830 (30 mm)				
ST1278 (12 mm)			X	
ST3078 (30 mm)				X

DISPLACEMENT BRACKETS

Holds Heidenhain type displacement sensors ST-1278 and ST-3078 to Thinline series weld heads as noted.



ELECTRODES

Highly conductive workpiece materials generally require electrodes of high resistance. Similarly, hard materials require softer, copper-based electrodes. When welding dissimilar materials such as copper and nickel, the normal choice would be a molybdenum electrode against the copper and a GLIDCOP electrode against the nickel.

If stored energy or half-cycle equipment is used to weld dissimilar materials, place the more resistive material against the negative electrode. Likewise, if similar materials with thickness ratios greater than 4:1 are welded, place the thinner material against the negative electrode.

To clean electrode surface and maintain shape, electrodes should be dressed with either 600 or 1000 grit silicon carbide paper, rather than with a file. Refer to page 7 for polishing disks.



ELECTRODE FORCE GAUGES

Electrode force gauges are used to establish weld schedules and to calibrate weld heads and handpieces. They are color coded to indicate the usable force range. The accuracy is $\pm 2\%$ of full scale.

Model	Capacity	Scale	Notes
FG20*	20 lbs	20 lbs x .2 lb	Serialized
FG100*	100 lbs	100 lbs x 1 lb	Serialized
FG200*	200 lbs	200 lbs x 2 lb	Serialized
FG10kg*	10 kg	10 kg x 0.1 kg	Serialized
FG100kg*	100 kg	100 kg x 1 kg	Serialized

*Calibration Certificate models also available

ELECTRODE MATERIALS

GLIDCOP - DISPERSION STRENGTHENED COPPER with 0.15% ALUMINUM OXIDE - 68B Rockwell hardness, 92% conductivity. Longer life, greater thermal stability, higher strength than RWMA 2. Generally interchangeable with RWMA 2 without changing schedules. All AMADA MIYACHI weld heads are supplied with GLIDCOP electrodes.

RWMA 2 - COPPER CHROMIUM ALLOY - 83B Rockwell hardness, 85% conductivity. Used for welding steels, nickel alloys and other high resistance materials.

RWMA 3 - COPPER COBALT BERYLLIUM ALLOY - 100B Rockwell hardness, 48% conductivity. Used for welding high resistance materials requiring high weld forces.

RWMA 11 - COPPER TUNGSTEN ALLOY 99B Rockwell hardness, 46% conductivity. Usually inserted into an RWMA 2 shank. Used for welding cuprous and precious metals. Used for light projection welding dies.

RWMA 13 - TUNGSTEN - 70A Rockwell hardness, 32% conductivity. Usually inserted into an RWMA 2 shank. Cannot be machined but may be ground to the desired shape. Used to weld non-ferrous metals such as copper and brass.

RWMA 14 MOLYBDENUM - 90B Rockwell hardness, 31% conductivity. Usually inserted into an RWMA 2 shank. Machineable. Used for welding copper, silver, gold and their alloys.

EP0400 - 1/8 in dia. PROBE ELECTRODES 6-32 NC2 thread
Used with THP and PHP handpieces

Model	Material
EP0402	RWMA 2
EP0403	RWMA 3
EP0450	GLIDCOP

EP0400 Series Electrodes

1/8 Inch Electrodes

E00400 - 1/8 in dia. OFFSET ELECTRODES
Used with 80 Series weld heads

Model	Material
E00402	RWMA 2
E00403	RWMA 3
E00411	RWMA 11 Insert
E00413	RWMA 13 Insert
E00420	Moly Insert

E00400 Series Electrodes

* Copper Alloy
** Refractory Alloy Insert

ES0400 - 1/8 in dia. STRAIGHT ELECTRODES
Used with 80, 82 weld heads

Model	Material
ES0402	RWMA 2
ES0403	RWMA 3
ES0411	RWMA 11 Insert
ES0413	RWMA 13 Insert
ES0420	Moly Insert
ES0450	GLIDCOP

ES0400 Series Electrodes

* Copper Alloy
** Refractory Alloy Insert

ESG0402 - 1/8 in dia. STRAIN GAUGE ELECTRODES Used with THP

Model	Material
ESG0402	RWMA 2

ESG0400 Series Electrodes For Strain Gauges

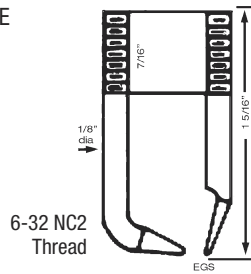

ET0400 - 1/8 in dia. TWEEZER ELECTRODES Used with THP AND PHP

Model	Material
ET0402	RWMA 2
ET0403	RWMA 3
ET0411	RWMA 11 Insert
ET0413	RWMA 13 Insert
ET0420	Moly Insert
ET0450	GLIDCOP

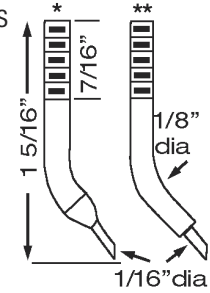

* Copper Alloy
** Refractory Alloy Insert

1/4 Inch Electrodes

EP0800 - 1/4 in dia. PROBE ELECTRODES Used with GHP AND HFP handpieces

Model	Material
EP0802	RWMA 2
EP0803	RWMA 3
EP0811	RWMA 11 Insert
EP0820	Moly Insert

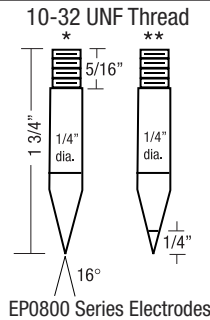

* Copper Alloy
** Refractory Alloy Insert

ES0800 - 1/4 in dia. STRAIGHT ELECTRODES Used with 82, 83, 84, and 180 Series weld heads

Model	Material
ES0802	RWMA 2
ES0803	RWMA 3
ES0850	GLIDCOP
ES0811	RWMA 11 Insert
ES0813	RWMA 13 Insert
ES0820	Moly Insert
ES0820A	1/8 in dia Moly Insert

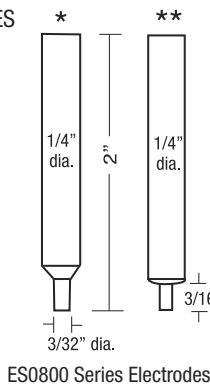

* Copper Alloy
** Refractory Alloy Insert

EP0900 - 5/16 in dia. ELECTRODES

	Description	A"	B"
EP0902	Straight	5/16	2.00
EP0902-90	90 degree	5/16	1.37
EP0902-35	35 degree	5/16	2.00

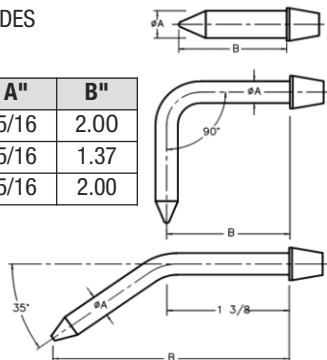

Unless otherwise noted, all material is RWMA Class II copper

ES0800B - 1/4 in dia. BRAZED INSERT ELECTRODES Used with 82, 83, 84 and 180 Series weld heads

Model	Material
ES0813B	RWMA 13 Insert
ES0820B	Moly Insert

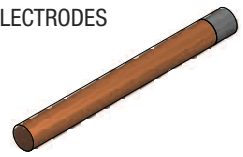

ES0800B Series Electrodes

ES0800E - .245 in dia. ECCENTRIC STRAIGHT ELECTRODES Used with 88, 89 and 188 weld heads and HE38V and HE88 holders

Model	Material
ES0802E	RWMA 2
ES0803E	RWMA 3
ES0850E	GLIDCOP
ES0820E	Moly Insert
ES0850ES	GLIDCOP (.062 in Face)

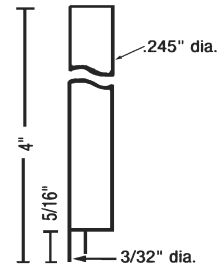

ES0800E Series Electrodes

Other Electrodes

ETB Table Electrodes - RWMA 2

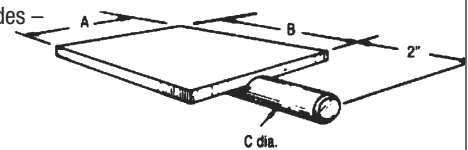

	A"	B"	C"	Used with
ETB2	2	1-3/4	3/8	80 Series
ETB3	3	3	5/8	90, 180 Series

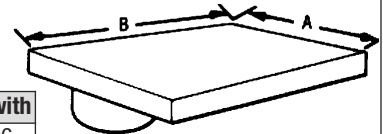

	A"	B"	Used with
ETB4	3	3-3/4	80, 86

EW4002 1.25 in WHEEL ELECTRODE RWMA2, Used with HW1090

HW1090 Holder with EW4002 Wheel

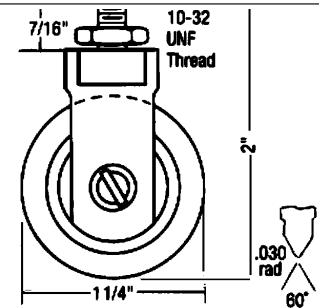

4-38924-01 - 73-Z pincer electrode, Moly, sold as pair

Model	Material
4-38924-01	Molybdenum

73-Z pincer electrode

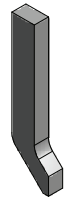

Electrode Rod (12 in length)

Model	Material	Dia.(in)	Model	Material	Dia.(in)
ER0213	RWMA 13	1/16	ER0802	RWMA 2	1/4
ER0220	MOLY	1/16	ER0803	RWMA 3	1/4
ER0402	RWMA 2	1/8	ER0811*	RWMA 11	1/4
ER0403	RWMA 3	1/8	ER0820*	Moly	1/4
ER0413	RWMA 13	1/8	ER0850	GLIDCOP	1/4
ER0420	MOLY 1/8	1/8	ER1202	RWMA 2	3/8
ER0450	GLIDCOP	1/8	ER2002	RWMA 2	5/8

* 8 in long

UNIBOND® ELECTRODES

Unibond electrodes are used for parallel gap bonding and reflow soldering. Generally, RWMA2 copper Unibond electrodes are used with resistive and/or hard materials such as gold plated kovar and nickel. Molybdenum Unibond electrodes are used for bonding conductive or soft materials such as copper or gold. The face of a Unibond electrode is 0.020 in (0.5 mm) wide by 0.030 in (0.75 mm) deep. In unfixtured applications, this limits their use to bonding ribbons (wire) which are at least 0.010 in (0.25 mm) wide because of the limited visibility.

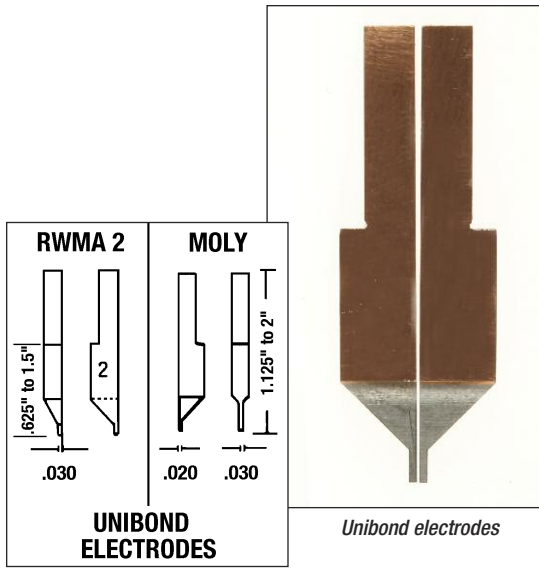

Model	Material	FACE			
		Length	Width	Depth	Length
EU1000	RWMA2	1.125 in	.020	.030	.080
EU1002	RWMA2	2 in	.020	.030	.080
EU2030M	Copper Clad Moly	1.125 in	.020	.030	.080
EU2030ML	Moly	2 in	.020	.030	.080
EU2537M	Moly	1.125 in	.025	.037	.100
EU2030MR	Moly	1.125 in	.020	.030	.080

UNITIP® ELECTRODES

Unitips are electrodes for parallel gap bonding of gold plated kovar, copper, or gold ribbons (wires) which are smaller than 0.010 in (0.25 mm). They are made from two pieces of molybdenum, which are permanently bonded to an insulating spacer. This fixed gap and bonded construction results in a tip which wears uniformly when properly dressed. The length of the Unitip and the flat area on the front allows it to bond ribbons extremely close to the walls of packages as deep as 0.450 in (11.5 mm). The narrower Thinline “L” series Unitips have a tapered profile, enabling them to be used closer to the corners of packages.

Model	FACE				Max. force oz.	Max. force kgf.
	Width	Depth	Gap	Length		
UTM111L	.009	.010	.001	.025	33	.94
UTM112L	.010	.010	.002	.025	33	.94
UTM152L	.010	.005	.002	.025	17	.47
UTM222L	.018	.020	.002	.050	132	3.75
UTM237L	.030	.020	.007	.050	161	4.57
UTM111C	.009	.010	.001	.025	33	.94
UTM112C	.010	.010	.002	.025	33	.94
UTM222C	.018	.020	.002	.050	132	3.75
UTM224C	.020	.020	.004	.050	132	3.75
UTM224L	.020	.020	.004	.050	132	3.75
UTM112CS	.010	.010	.002	.015	33	.94
UTM112LS	.010	.010	.002	.015	33	.94

All dimensions in inches unless noted.
NOTE: Refer to Unitip & Unibond Electrodes Data Sheet 991-461.

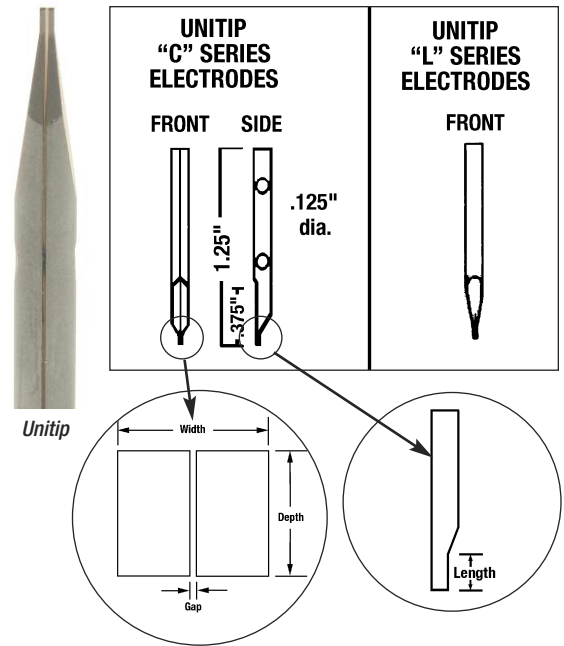

GOLD PLATED KOVAR RIBBON

Model	Size
KR207	.002 in x .0065 in x 10 ft
KR306	.002 in x .010 in x 20 ft
KR307	.002 in x .005 in x 20 ft
KR310	.003 in x .010 in x 20 ft
KR315	.003 in x .015 in x 20 ft
KR320	.003 in x .020 in x 20 ft

POLISHING DISKS

Model PD Polishing Disks, 600 and 1000 grit silicon carbide, 1.5 in diameter.
Package of 50.
10-031-02, PD-600
10-031-02-01, PD-1000



1 1/2 in dia. Polishing Disk

Model CPD Ceramic Polishing Disks, 1 in square x .025 in thick.
Package of 20.



1 in square Ceramic Polishing Disk

NICKEL TAB MATERIAL

Part number	Part Name	Description
145-025	145-025, Nickel Battery Tab	Nickel 201
	.250 in x 1.125 in x .005 in	
145-026	145-026, Nickel Battery Tab	Nickel 201
	.375 in x 1.125 in x .005 in	

Other sizes available upon request

CABLES, TERMINALS, CONNECTORS AND ADAPTERS











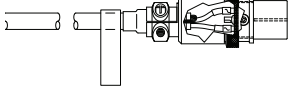
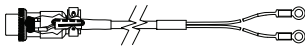

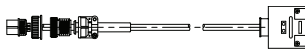

Common size weld cables, sold in pairs

#2 AWG Cables		
Part Number	Length	Terminal Size
18-2U-AA-12	12 in	5/16
18-2U-AA-16	16 in	5/16
18-2U-AA-18	18 in	5/16
18-2U-AA-24	24 in	5/16
18-2U-AA-28	28 in	5/16
18-2U-AA-36	36 in	5/16
18-2U-AA-40	40 in	5/16
18-2U-AA-48	48 in	5/16
18-2U-DD-6	6 in	10-32
18-2U-DD-14	14 in	10-32
18-2U-DD-17	17 in	10-32
18-2U-DD-30	30 in	10-32
18-2U-DD-36	36 in	10-32
18-2U-DD-42	42 in	10-32
18-2U-DD-48	48 in	10-32

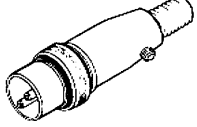
2/0 AWG Cables		
Part Number	Length	Terminal Size
18-20U-BB-12	12 in	5/16
18-20U-BB-16	16 in	5/16
18-20U-BB-24	24 in	5/16
18-20U-BB-30	30 in	5/16
18-20U-BB-36	36 in	5/16
18-20U-BB-48	48 in	5/16

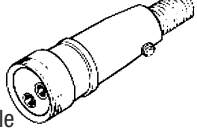
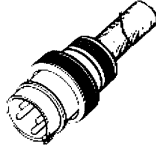
4/0 AWG Cables		
Part Number	Length	Terminal Size
18-40U-EE-24	24 in	5/16
18-40U-EE-36	36 in	5/16
18-40U-EE-45	45 in	5/16
18-40U-EE-48	48 in	5/16
18-40U-EE-57	57 in	5/16
18-40U-EE-60	60 in	5/16
18-40U-JJ-11	11 in	7/16
18-40U-JJ-12	12 in	7/16
18-40U-JJ-24	24 in	7/16
18-40U-JJ-36	36 in	7/16
18-40U-JJ-42	42 in	7/16
18-40U-JJ-44	44 in	7/16
18-40U-JJ-48	48 in	7/16
18-40U-JJ-60	60 in	7/16
18-40U-JJ-70	70 in	7/16
18-40U-JJ-72	72 in	7/16

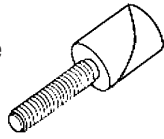
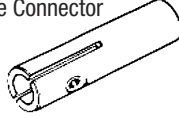
Special size cables can be purchased on request

<p>A 4-36578-01, Voltage cable, 15 ft long with flying leads (large scale applications typically)</p> 	<p>A 4-35670-01, Voltage cable, 6 ft long with #2 stud size ring terminals 4-35670-02, Voltage cable, 6 ft long with #6 stud size ring terminals 4-35670-03, Voltage cable, 6 ft long with #8 stud size ring terminals</p> 
<p>B 10-381-01, Firing switch Extension Cable, 6 ft long</p> 	<p>J 18-042-01, Current Coil Extension Cable, 15 in long</p> 
<p>C 18-045-01, Transformer Sense Cable, 15 ft long</p> <p>Mates with IS and ISA series welders and IT-XXXX-X transformers *Not for use with IS-300A</p> 	<p>K 18-046-01, transformer sense cable, 6' long, mates with IS-300A and IT-XXXX-X transformers</p> 
<p>D SRCN6A21-16P, MM-370 Multi-pin Connector</p> 	<p>P Standard Firing Switch Panel Mount Receptacle #18 AWG 550-001</p> 
<p>E AA-8801, GS-1830 Extension Cable, 15 meters, used with MM-370 and IPB-5000A</p> 	<p>S #18 AWG Firing Switch Plug-Male 520-001</p> 
<p>F #18 AWG 4-PIN Female Receptacle for Footswitch 550-006</p> 	<p>T #18 AWG Firing Switch Jack-Female 520-011</p> 
<p>G #18 AWG 4-PIN Male Plug for Footswitch 520-009</p> 	<p>V DFS/88 Dual Firing Switch Adapter, Series configuraton</p> 
<p>H #2 AWG Cable Connector (for HFP) 4-02688-01</p> 	<p>W #6 AWG Cable Connector 4-28071-02, used with PHP and THP</p> 
<p>X 1. Voltage Sense panel mount receptacle-Male 550-070</p> 	<p>2. Voltage Sense plug- Female, 520-110</p> 

ELECTRODE HOLDERS AND ADAPTERS

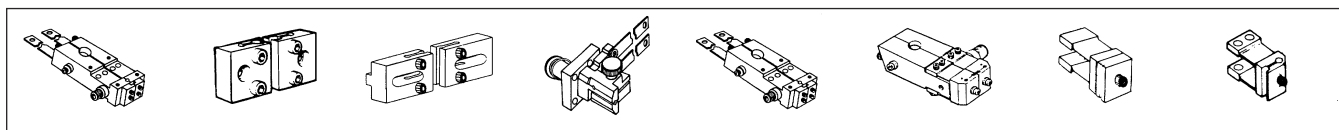

HE87 HOLDERS, UNITIP/THERMODE for 87F and 87A.
HE88 ELECTRODE HOLDER Holder .245 in dia. ES0800 Series electrodes in 88 Weld Head. Set (2)
HE188 ELECTRODE HOLDER Holder .245 in dia. ES0800E Series electrodes in 188 Weld Head. Set (2)
HE50 HOLDERS, UNITIP for 50F and 50A Weld Heads.
HE50RF HOLDER, THERMODE, for 50F and 50A Weld Heads.
HE50UB FLEXURE SET holds Unibond electrodes and Unitip adapter in 50 Weld Head.
HE127SFRE ROUND ELECTRODE HOLDER SET Holds 1/8 in dia. electrodes in 86 Weld Heads. Set (2)
HE127SF STANDARD FIXTURE SET Holds Unibond electrodes in 86 Weld Head. Set (2)

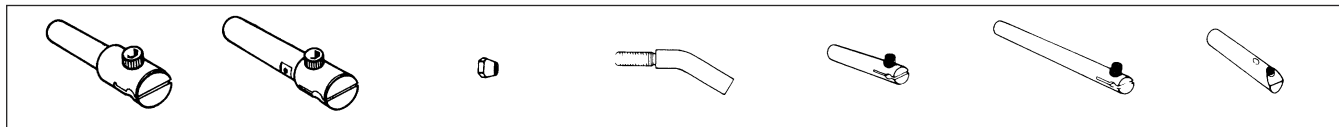

HE1208 ELECTRODE HOLDER, 3/8 dia. x 2 long. for 1/4 dia. electrodes.
HE1600 STANDARD ELECTRODE HOLDERS, for 84 Weld Heads, holds 1/4 in electrodes, 1/2 in dia. x 2.312 Long.
ELN Nuts for THP and PHP Handpieces. Pkg. (15)
HE30GH 30° ANGLED ELECTRODE HOLDER Holds EP0800 Series Electrodes in GHP at 30° angle.
HE1200S STANDARD 2 in ELECTRODE HOLDER Holds 1/8 in dia. electrodes in 80 Weld Head.
HE1200L 3-1/2 in ELECTRODE HOLDER Holds 1/8 in dia. electrodes in 80 Weld Head.
HE0435 35° OFFSET ELECTRODE HOLDER Holds 1/8 in dia. electrodes in 80 Weld Head.

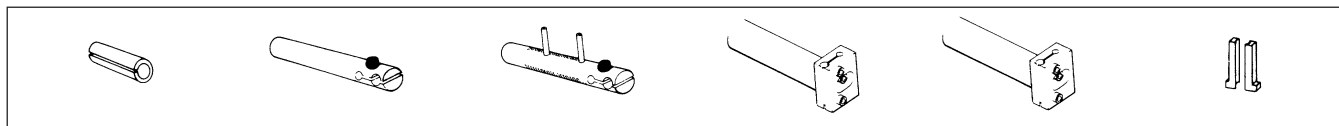

HE08040 SLEEVE ADAPTER Adapts 3/8 in electrode holder (for 1/8 in electrodes) to 180 and 188 Weld Heads. Set (2)
HE2000 ELECTRODE HOLDER Holds 1/4 in electrodes in 180 Weld Head.
HE2000WC WATER COOLED ELECTRODE HOLDER Holds 1/4 in dia. and 1/8 in dia. electrodes in 88, 180, 188 Weld Heads. Includes plastic tubing. Set (2)
HE38V ELECTRODE HOLDER Holds .245 in dia. ES0800E Series electrodes in 188 Weld Head. Set (2)
HE38V04 ELECTRODE HOLDERS, vertical, anti-rotation feature. Holds 1/8" dia series electrodes in 188 Weld Head
UTA UNITIP ADAPTER SET adapts HE50UB and 86 Weld Heads to hold UNITIPS. Set (2)

Series 320 Electrode Holders

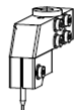

Part Number	12-100-01	12-100-02	12-102-01	12-103-01	12-103-02	12-101-01	12-101-02
Part Name	Opposed holder inline	Opposed metric holder inline	Unitip holder	Unibond holder	Microjoin holder	Opposed offset holder	Opposed offset metric holder

* includes all mounting hardware

STARTER KITS

Starting new welding project can seem daunting at first. Not only do you need to purchase the welding equipment, but also need to consider peripheral equipment to ensure that the process is successful and safe. We have created start-up kits for the different products to help you get started.

Kit	10-415-01	10-416-01	10-417-01	10-418-01
Includes	Includes 20 lbs force gauge, 1000 grit polishing disc, 10X loupe, safety glasses and various electrodes	Includes 20 lbs force gauge, 1000 grit polishing disc, 10X loupe, safety glasses and various electrodes	Includes 100 lbs force gauge, 600 grit polishing disc, 10X loupe, safety glasses and various electrodes	Includes 100 lbs force gauge, 600 grit polishing disc, 10X loupe, safety glasses and various electrodes
Weld Head Model	80/71 Series	88 Series	180/73 Series	188 Series

CALIBRATION KITS

Calibration of your equipment is essential to maintain proper operation, calibration should be done on an annual basis. These kits include everything needed to calibrate the UB/DC25 or HF25/27 power supplies. Choose the kit with or without oscilloscope depending on your needs.

Part Number	Part Name	Description
10-377-02	UB/DC25 Calibration Kit	Calibration kit for UB/DC25, includes shunt, cables and necessary hardware
10-377-03	UB/DC25 Calibration Kit with Oscilloscope	Calibration kit for UB/DC25, includes oscilloscope, shunt, cables and necessary hardware
10-410-01	HF25/27 Calibration Kit	Calibration kit for HF25/27, includes shunt, cables and necessary hardware
10-410-02	HF25/27 Calibration Kit with Oscilloscope	Calibration kit for HF25/27, includes oscilloscope, shunt, cables and necessary hardware



1820 S. Myrtle Ave. • Monrovia, CA 91016 US
 T: (626) 303-5676 • F: (626) 358-8048
info@amadamiyachi.com • www.amadamiyachi.com
 ISO 9001 Certified Company • 24/7 Repair Service: 1-866-751-7378

AMERICAS
AMADA MIYACHI AMERICA (Midwest Office)
 Detroit, Michigan
 T: (248) 313-3078
midwestsales@amadamiyachi.com

AMADA MIYACHI DO BRASIL LTDA.
 Sao Paulo, Brasil
 T: +55-11-4193-3607
antonio.ruiz@amadamiyachi.com

EUROPE
AMADA MIYACHI EUROPE GmbH
 Munich, Germany
 T: +49-89-839403-0
info@amadamiyachi.eu

ASIA
AMADA MIYACHI CO., LTD.
 Isehara, Japan
 T: +81-47-125-6177
sales@miyachi.com

AMADA MIYACHI SHANGHAI CO., LTD.
 Shanghai, China
 T: +86-21-6448-6000
jwu@msc.miyachi.com

AMADA MIYACHI KOREA CO., LTD.
 Seoul, Korea
 T: +82-4-7125-6177
dykim@mkc.miyachi.com

AMADA MIYACHI TAIWAN CO., LTD.
 Taipei, Taiwan R.O.C.
 T: +886-2-2585-0161

AMADA (THAILAND) CO., LTD.
 Bangkok, Thailand
 T: +66-2-170-5977
info@mtl.miyachi.com

AMADA VIETNAM CO., LTD.
 Ha Noi, Vietnam
 T: +84-4-6261-4583

AMADA MIYACHI INDIA PVT., LTD.
 Bangalore, Karnataka
 T: +91-80-4092-1749
 or +91-80-4092-3549
info@miyachiindia.com

AMADA MIYACHI AMERICA (Mexico Office)
 El Paso, Texas
 T: (915) 881-8765
mxsales@amadamiyachi.com

follow us on:



Specifications subject to change without notice. Copyright© 2017 AMADA MIYACHI AMERICA, INC. The material contained herein cannot be reproduced or used in any other way without the express written permission of AMADA MIYACHI AMERICA, INC. All rights reserved.